

**DESCRIPTION**

- ELECTRONIC BALLAST
- ELECTRONIC TRANSFORMER
- SWITCH MODE POWER SUPPLY

**FEATURES:**

- LOW THERMAL RESISTANCE
- HIGH INPUT RESISTANCE
- FAST SWITCHING
- ROHS COMPLIANT

**MAXIMUM RATINGS (T<sub>c</sub>=25°C)**

PARAMETER	SYMBOL	VALUE	UNIT
Drain-source Voltage	VDS	60	V
gate-source Voltage	VGS	±20	V
Continuous Drain Current	ID	155	A
Drain Current-Pulsed	IDM	500	A
Total Dissipation	PD	210	W
Junction Temperature	T <sub>j</sub>	150	°C
Storage Temperature Range	T <sub>stg</sub>	-55-150	°C
Single Pulse Avalanche Energy (L=0.5mH)	EAS	225	mJ

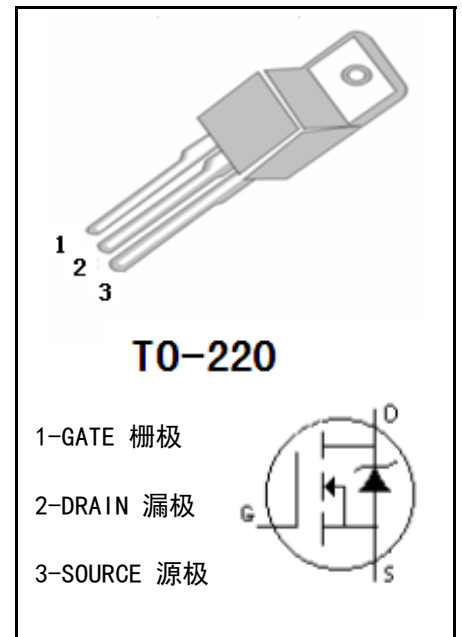
**MECHANICAL**

**ELECTRONIC CHARACTERISTICS (T<sub>c</sub>=25°C)**

CHARACTERISTICS	SYMBOL	TEST CONDITION	MIN	MAX	UNIT
Drain-source Breakdown Voltage	BVDSS	VGS=0V, ID=250 μA	60		V
Gate Threshold Voltage	VGS (TH)	VGS=VDS, ID=250 μA	2	4	V
Drain-source Leakage Current	IDSS	VDS=60V, VGS=0V		1	uA
Drain-Source Diode Forward Voltage	VSD	VGS=0V, IS=10A		1.2	V
Gate-body Leakage Current (VDS = 0)	IGSS	VGS=±20V		±100	nA
Static Drain-source On Resistance	RDS (ON)	VGS=10V, ID=20A		5	mΩ
Thermal Resistance Junction-case	RthJ-c			0.6	°C/W

■ DYNAMIC CHARACTERISTICS (T<sub>c</sub>=25°C)

CHARACTERISTICS	SYMBOL	TEST CONDITION	MIN	TYP	MAX	UNIT
Input Capacitance	C <sub>iss</sub>	V <sub>DS</sub> =35V, V <sub>GS</sub> =0V, f=1.0MHz	-	7200	-	pF
output Capacitance	C <sub>oss</sub>		-	385	-	pF
Reverse Transfer Capacitance	C <sub>rss</sub>		-	175	-	pF
Gate resistance	R <sub>G</sub>	V <sub>DS</sub> =0V, V <sub>GS</sub> =0V, f=1.0MHz	-	1.5	-	Ω

■ SWITCHING CHARACTERISTICS (T<sub>c</sub>=25°C)

CHARACTERISTICS	SYMBOL	TEST CONDITION	MIN	TYP	MAX	UNIT
Total Gate Charge	Q <sub>g</sub>	V <sub>DS</sub> =40V, I <sub>D</sub> =20A, V <sub>GS</sub> =10V	-	140	-	nC
Gate-Source Charge	Q <sub>gs</sub>		-	35	-	nC
Gate-Drain Charge	Q <sub>gd</sub>		-	41	-	nC

**CHARACTERISTICS CURVE**

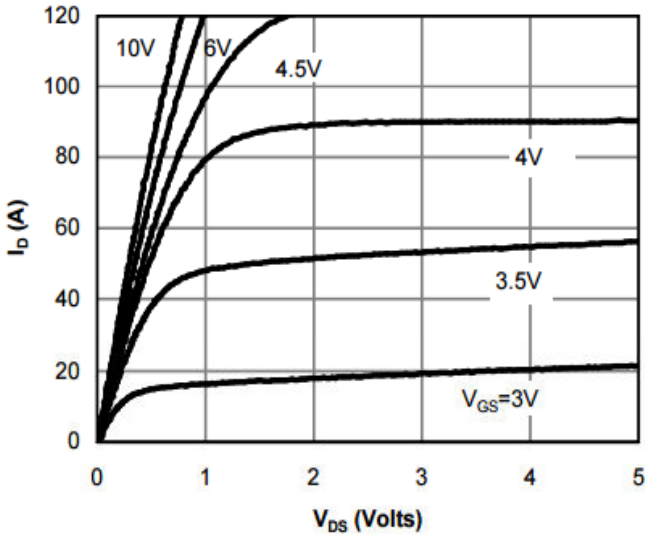

**Output Characteristic**

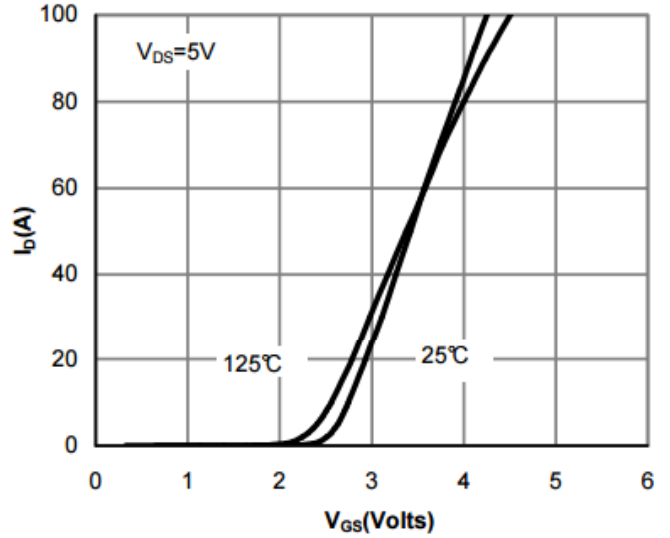

**Transfer Characteristic**

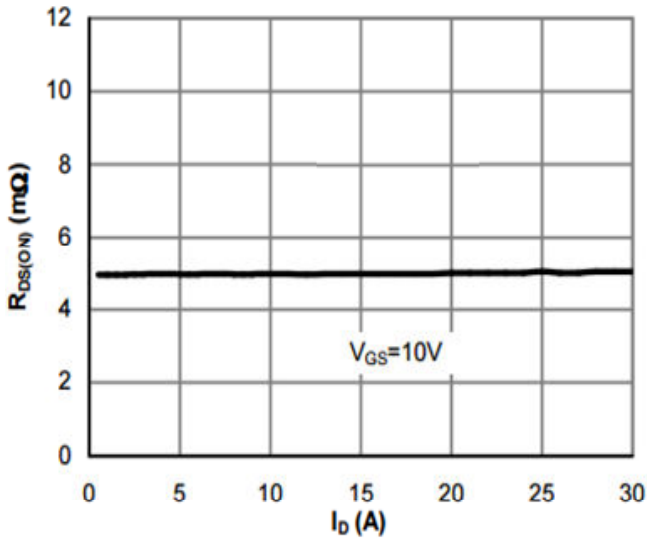

**On Resistance Vs Drain Current**

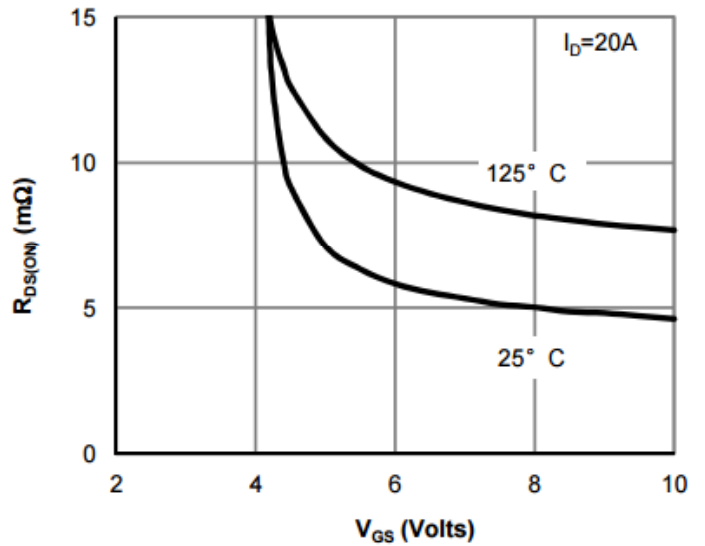

**On-Resistance vs. Gate-Source Voltage**

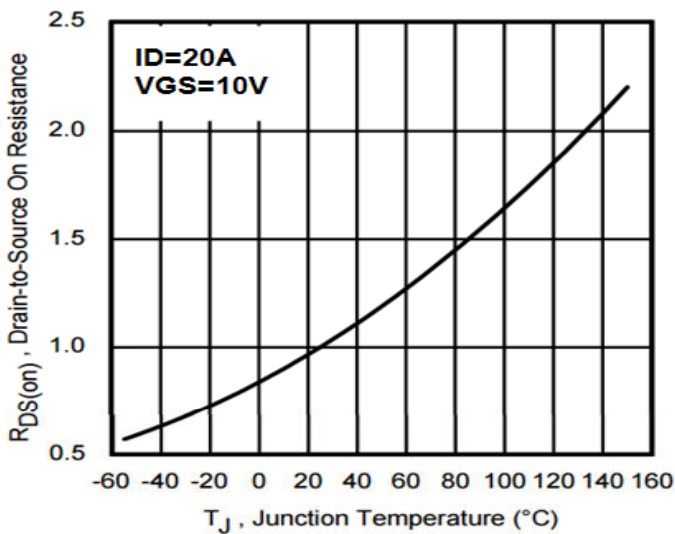

**On Resistance Vs Junction Temperature**

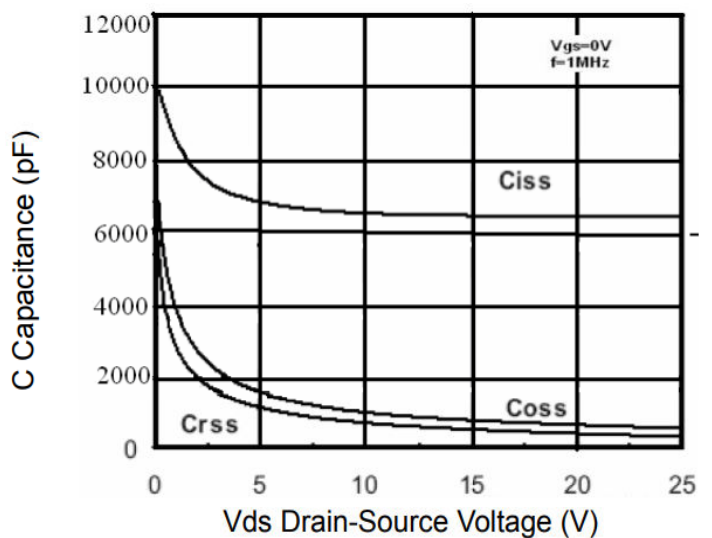

**Capacitance**

■ CHARACTERISTICS CURVE

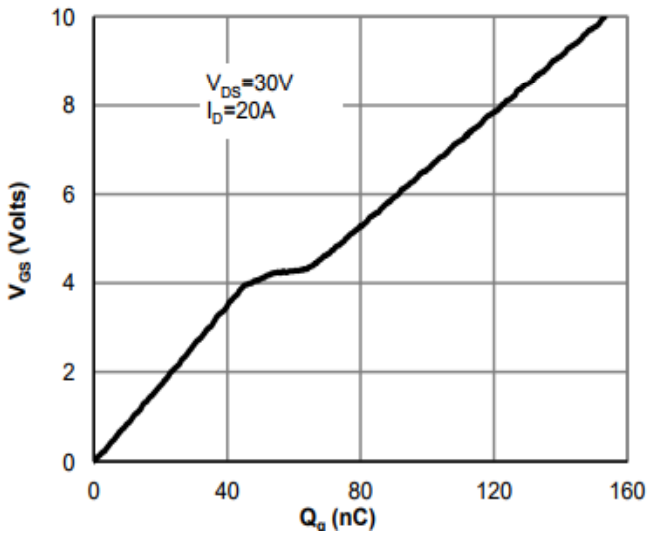

Gate Charge Waveform

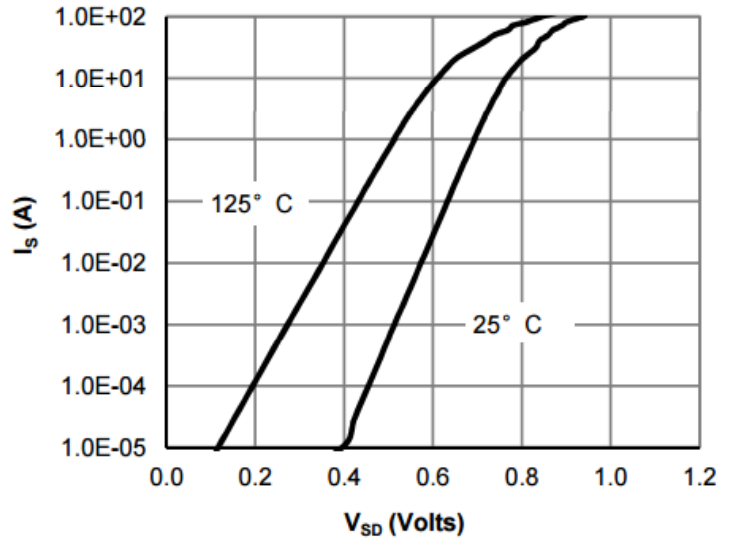

Source-Drain Diode Forward Voltage

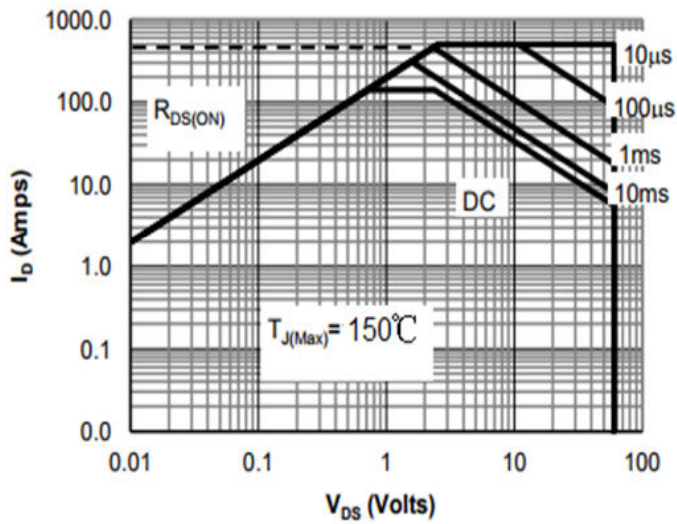

Maximum Safe Operating Area

**TO-220 MECHANICAL DATA**

UNIT: mm

SYMBOL	MIN	NOM	MAX	SYMBOL	MIN	NOM	MAX
A	4		4.8	e	2.44	2.54	2.64
B	1.2		1.4	F	1.1		1.4
B1	1		1.4	L	12.5		14.5
b1	0.75		0.95	L1	3	3.5	4
c	0.4		0.55	ΦP	3.7	3.8	3.9
D	15		16.5	Q	2.5		3
D1	5.9		6.9	Q1	2		2.9
E	9.9		10.7				

